



Commission
Regulation
(EU) 2023/826



SHUTTER AND WINDOW AUTOMATIONS

Valid from 1st March 2026



Line of home automations
developed to be **connected** and easy to operate.

The products in this line are highly industrialized, designed
with great attention to detail and a focus on the
quietness of the devices and **connected** electronics.

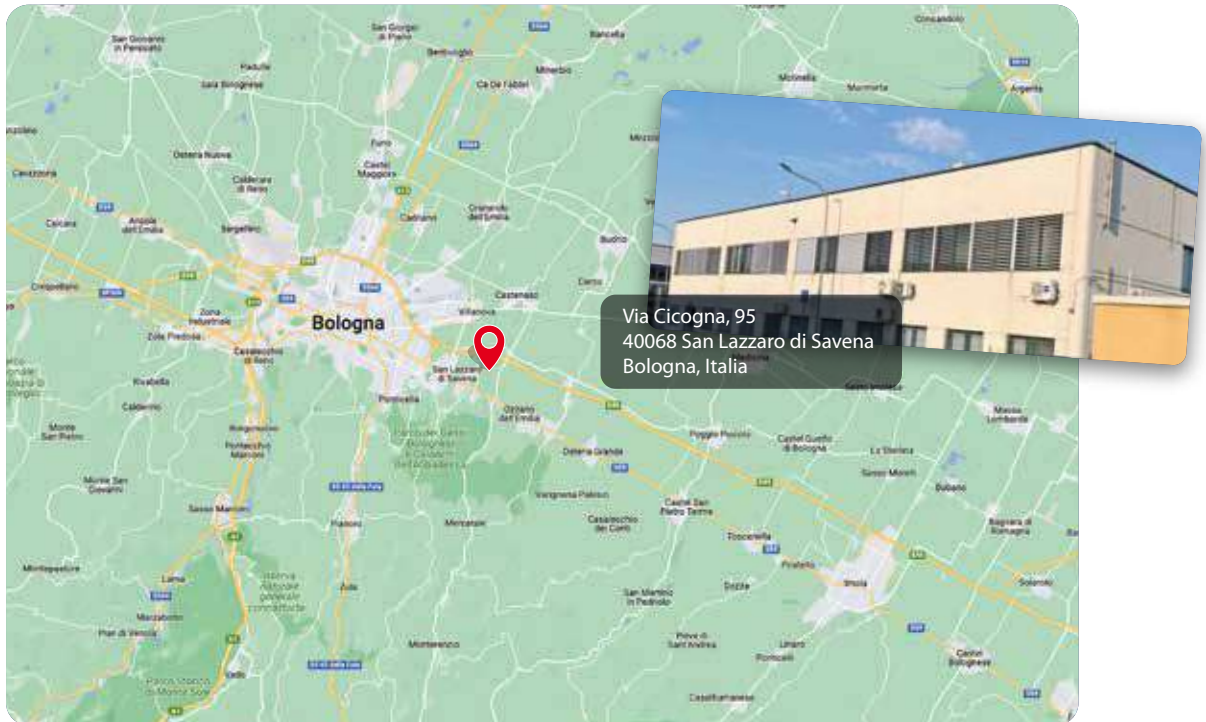

Proudly Made in Italy

Beematic products are designed and manufactured in Italy.
Every Beematic automation brings with it the values of Italian culture, known around the
world for its attention to design and attention to detail.

www.beematic.it

We are ACMI members

Assostruttori Chiusure e Meccanismi Italia

AB tecno is part of a network
that represents a relevant
opportunity of growth and
professional training for
our company > **www.assoacmi.it**



BEEMATIC is a registered trademark
owned by AB TECNO srl

Automation for hinged and sliding shutters

Product

Page

RHA

Automation for hinged shutters
 > NORMAL shutters
 > SPLIT shutters / PADOVANA shutters /TREVIGIANA shutters
 > FOLDING shutters / BOUND shutters

B6



RHA PLUG-IN

Automation for hinged shutters powered with rechargeable batteries

B19



SHU

Automations for sliding shutters

B26



**PLANO TWO
RAINS
WINDS 230**

Accessories for shutters

B29



RHA SET AND LEVERS FOR SWING SHUTTER SELECTION GUIDE

(paper configurator)



choose the RHA SET

1 - How many shutters do you have?



choose the length of the RHA SET

2 - How wide is your window/shutter?

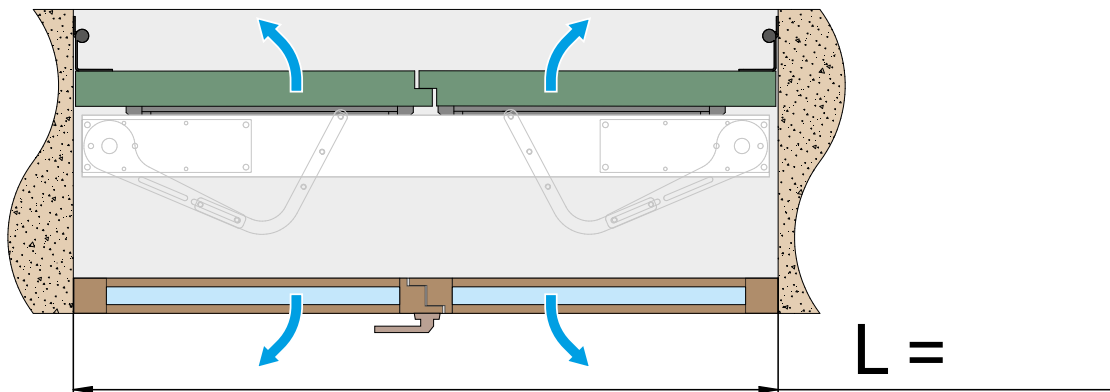

check the L min measurement (see page B18)
choose the Set larger than the width of your window (see page B10)

choose the right LEVER according to the type of shutter

3 - How much space do you have inside the shutter?

check the space D between the shutter (full side) and the window/gate/insect screen to select the correct lever

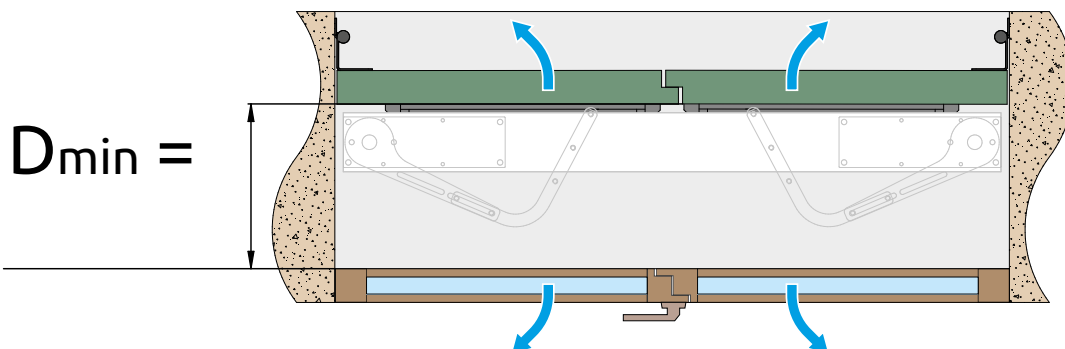

4 - What type of shutter do you need to motorise?

- NORMAL SHUTTERS
- SPLIT SHUTTERS / PADOVANA SHUTTERS / TREVIGIANA SHUTTERS
- FOLDING SHUTTERS / BOUND SHUTTERS
- > see page B13



choice of box COLOUR

5 - What colour would you like the RHA automation SET to be?

By default we supply it WHITE or anodised aluminium (SILVER) colour.
 We can also supply RHA automation in GREEN (RAL 6005) or BROWN (RAL 8017) (see page B10).
 If you require a specific colour, please tell us the RAL code for that colour (see page B12).

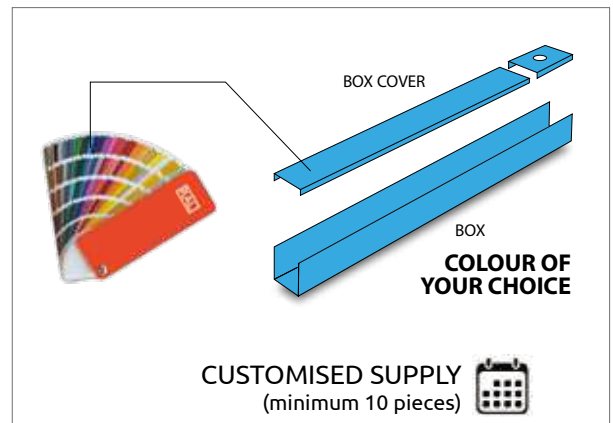
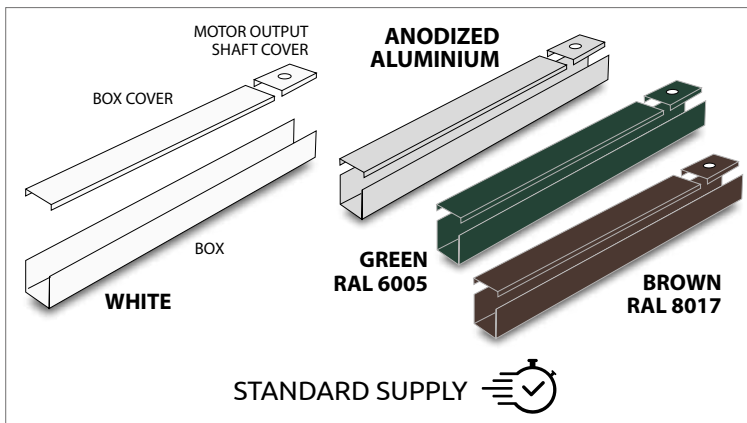

choice of POWER SUPPLY

6 - How would you like to power the automation?

Normal power supply
 > see page B6



Normal power supply with HOME
 AUTOMATION (DOMOTICA)



Rechargeable battery
 > see page B19



accessories

7 - Choose the optional accessories you prefer to enhance the safety and control of the automation

CONTROL ACCESSORIES FOR
 FOR SHUTTERS are available
 to manage your automations
 > see page B29



AUTOMATION FOR HINGED SHUTTERS

**Reduced overall
dimensions to a minimum
for its category**

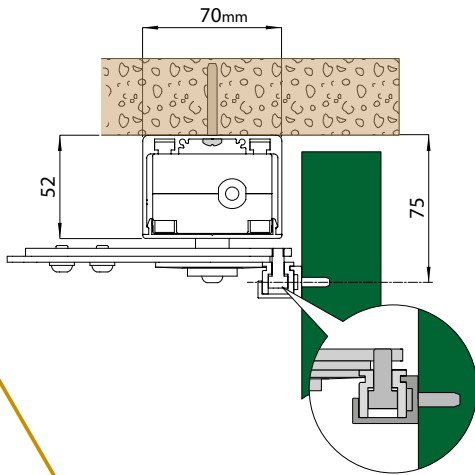

**Maximum strength
for its category**

Motor shaft output torque: 35Nm



**Different linkages
for each type of sash**



**"Dead man"
function**

Holding down for more than
2 seconds on the opening or
closing will **FORCE** the movement
in any wind condition



**Opening controls
and central locking
(standard)**

Control unit easily integrated
to home automation systems or
to sensors (e.g. in case of rain
all shutters are closed)



e.g. rain sensor
(optional)



HIGH QUALITY COMPONENTS

Certified excellence and superior quality for our components: with a **five-year warranty**, we ensure reliable and long-lasting performance for both **engine** and **control unit**. Our commitment to quality translates into peace of mind for the customer.



Gear motor

Control unit



To guarantee the **quality** and **traceability** of our products, we use matricular labels that **uniquely** identify each unit. This allows us to precisely monitor production and offer a personalised and secure service to our customers.

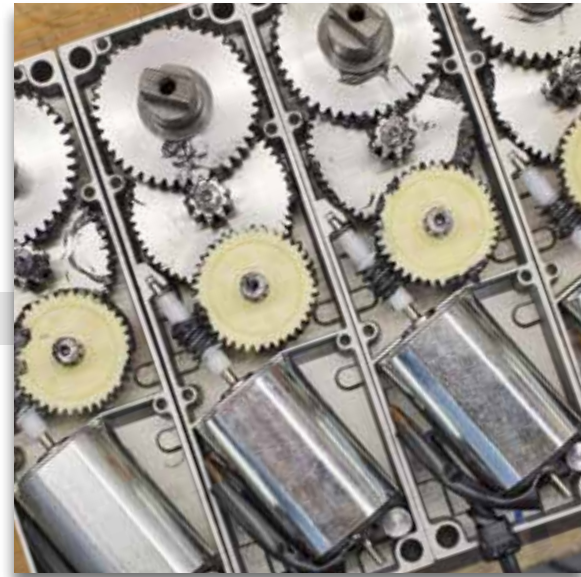

CERTIFIED SILENCE

In addition to the quality of our products, we can also certify the low noise of our mechanisms, achieved thanks to **precise mechanical and calibrated assembly**.

The RHA system offers a quiet and comfortable experience, proven by phonometric measurements, ensuring a quiet and pleasant environment in your home.





RHA

Automation for hinged shutters

Small, discreet and silent, it is the ideal automatism that thanks to its simple levers, opens and closes the blinds and casement shutters in your home. It can be applied even in case of existing window frames, remaining almost invisible, thanks to the small size of its structure and the white aluminum box (can be painted on request).
12V low-voltage motor.



RHA is an Egyptian god belonging to the religion of ancient Egypt, identified as the sun god.

Features and functions

Gear motor



Description	RHA1
Electromechanical actuator	for hinged shutters
Maximum capacity	30 kg (1 shutter) / 60 kg (2 shutters)
Service class	2 - light
Intermittency	S2 = 7 min / S3 = 15 percent
Power supply	12 Vdc
Power consumption	1.4 A
Torque / Thrust	35 Nm
Opening / closing speed	12 s/180°
Operating temperature	-20°C / +55°C
Degree of protection (with aluminum profile)	IP 44
Control panel	RHA2

Control unit



Description	RHA2
Control panel	for 1 or 2 motors 12 Vdc with built-in radio
Power supply	230 Vac / 50-60Hz
Energy saving	reduced consumption in stand-by and during use
Number of motors	1 or 2
Motor power supply	12 Vdc / 1,4 A
Electroblock	12 Vdc
ODS - Obstacle detection (causes stop or reversal of the maneuver if obstacle is detected)	Yes
Opening command	Yes
Closing command	Yes
Dead man command	Yes
Centralized opening command	Yes
Centralized closing command	Yes

Reducible to size:

- 1 hinged shutter min = 600 mm (without electroblock)
- 2 hinged shutters min = 800 mm (without electroblock)

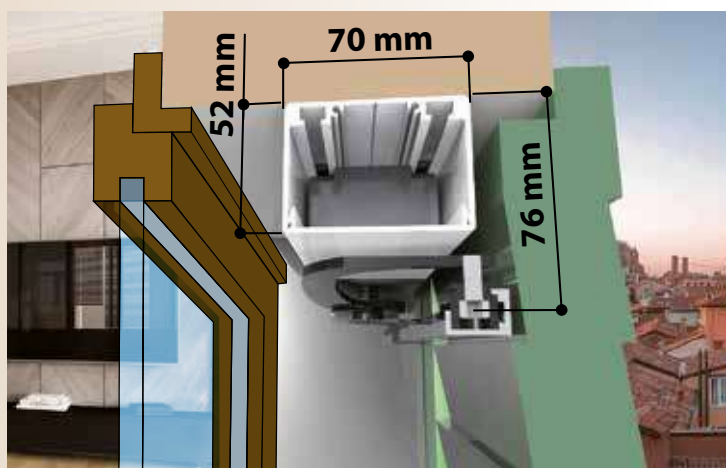

Dimension of RHA section

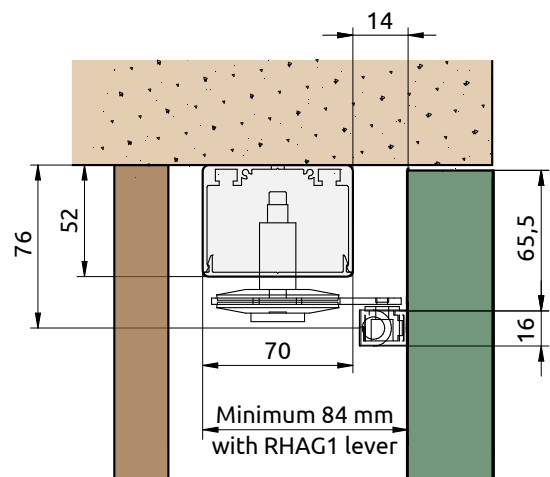

LOW CONSUMPTION = SAVINGS GUARANTEED

The control units in the BEEMATIC range comply with Regulation (EU) 2023/826, which *“establishes eco-design requirements for the energy consumption of household and office electrical and electronic equipment in off, standby and networked standby modes, in accordance with Regulation 2023/826 of the European Parliament and of the Council”.*

This means that BEEMATIC automation control units have very low standby power consumption, providing considerable savings.

Commission Regulation (EU) 2023/826



5-YEAR WARRANTY

5-year warranty valid on products of the brand BEEMATIC: gear motors, control units (RHA2 e SHU2), automation sets and lever kits for swing shutters* and radio transmitters.

* excluding batteries



2-YEAR WARRANTY

2-year warranty valid for control units (RHA2 POWER) and for BEEMATIC products batteries.



battery



**DOWNLOAD OUR CATALOGUE OF AUTOMATION SYSTEMS
RHA DEDICATED TO INTERFACING WITH ENVIRONMENTS
EQUIPPED WITH HOME AUTOMATION SYSTEMS**



FOLDING SHUTTER APPLICATION



APPLICATION WITH MOTOR ON THE SILL



INTERIOR WINDOW APPLICATION

PRICE LIST - AUTOMATION SET

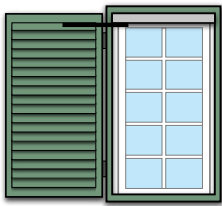

1 SHUTTER

Automation set for 1 hinged shutter (30 kg max)

The set contains, in a single package, automation and control accessories needed to make a single hinged shutter. Composition:

- no.1 actuators complete with control panel with built-in radio receiver
- support profile and closing casing both in **WHITE painted aluminum (RAL9010)**

STANDARD SUPPLY

WHITE painted aluminum (RAL9010)

Code	Name	Item description	Colour
APE-150/4510	RHASETM865	Set for 1 shutter with a width of 865 mm (can be reduced to size) <u>without levers</u>	
APE-150/4511	RHASETM1200	Set for 1 shutter with a width of 1200 mm (can be reduced to size) <u>without levers</u>	



Anodized aluminum (SILVER colour)

Code	Name	Item description	Colour
APE-150/4510.S	RHASETM865.S	Set for 1 shutter with a width of 865 mm (can be reduced to size) <u>without levers</u>	
APE-150/4511.S	RHASETM1200.S	Set for 1 shutter with a width of 1200 mm (can be reduced to size) <u>without levers</u>	



GREEN painted aluminum (RAL 6005)

Code	Name	Item description	Colour
APE-150/4510.6005	RHASETM865.6005	Set for 1 shutter with a width of 865 mm (can be reduced to size) <u>without levers</u>	
APE-150/4511.6005	RHASETM1200.6005	Set for 1 shutter with a width of 1200 mm (can be reduced to size) <u>without levers</u>	



BROWN painted aluminum (RAL 8017)

Code	Name	Item description	Colour
APE-150/4510.8017	RHASETM865.8017	Set for 1 shutter with a width of 865 mm (can be reduced to size) <u>without levers</u>	
APE-150/4511.8017	RHASETM1200.8017	Set for 1 shutter with a width of 1200 mm (can be reduced to size) <u>without levers</u>	



The RAL paint is supplied with a standard gloss value of 30/40 GU.

Other RHASET colours > see page B12



ATTENTION:
IF THE AUTOMATION SYSTEM (1 OR 2 DOORS) NEEDS TO BE INSTALLED IN ENVIRONMENTS EQUIPPED WITH HOME AUTOMATION SYSTEMS, IT IS NECESSARY TO CHOOSE THE MOTORISATION FROM THE SPECIFIC CATALOGUE (see QR code).



PRICE LIST - AUTOMATION SET

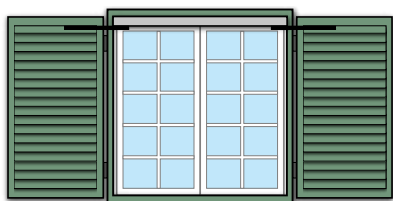

2 SHUTTERS

Automation set for 2 hinged shutters (30Kg x 2 shutters = 60 kg max)

The set contains, in a single package, automation and control accessories needed to make a two-hinged shutter. Composition:

- no.2 actuators complete with control panel with built-in radio receiver
- support profile and closing casing both in **WHITE painted aluminum (RAL9010)**

STANDARD SUPPLY

WHITE painted aluminum (RAL9010)

Code	Name	Item description	Colour
APE-150/4500	RHASETD1200	Set for 2 shutters with a width of 1200 mm (can be reduced to size) <u>without levers</u>	
APE-150/4515	RHASETD1525	Set for 2 shutters with a width of 1525 mm (can be reduced to size) <u>without levers</u>	
APE-150/4520	RHASETD2000	Set for 2 shutters with a width of 2000 mm (can be reduced to size) <u>without levers</u>	



Anodized aluminum (SILVER colour)

Code	Name	Item description	Colour
APE-150/4500.S	RHASETD1200.S	Set for 2 shutters with a width of 1200 mm (can be reduced to size) <u>without levers</u>	
APE-150/4515.S	RHASETD1525.S	Set for 2 shutters with a width of 1525 mm (can be reduced to size) <u>without levers</u>	
APE-150/4520.S	RHASETD2000.S	Set for 2 shutters with a width of 2000 mm (can be reduced to size) <u>without levers</u>	



GREEN painted aluminum (RAL 6005)

Code	Name	Item description	Colour
APE-150/4500.6005	RHASETD1200.6005	Set for 2 shutters with a width of 1200 mm (can be reduced to size) <u>without levers</u>	
APE-150/4515.6005	RHASETD1525.6005	Set for 2 shutters with a width of 1525 mm (can be reduced to size) <u>without levers</u>	
APE-150/4520.6005	RHASETD2000.6005	Set for 2 shutters with a width of 2000 mm (can be reduced to size) <u>without levers</u>	

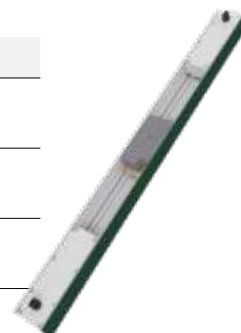

BROWN painted aluminum (RAL 8017)

Code	Name	Item description	Colour
APE-150/4500.8017	RHASETD1200.8017	Set for 2 shutters with a width of 1200 mm (can be reduced to size) <u>without levers</u>	
APE-150/4515.8017	RHASETD1525.8017	Set for 2 shutters with a width of 1525 mm (can be reduced to size) <u>without levers</u>	
APE-150/4520.8017	RHASETD2000.8017	Set for 2 shutters with a width of 2000 mm (can be reduced to size) <u>without levers</u>	



The RAL paint is supplied with a standard gloss value of 30/40 GU.

Other RHASET colours > see page B12

Other RHASET colours

RHASET automations can also be requested with RAL supplied by the customer. The RAL paint is supplied with a standard **gloss value of 30/40 GU**.



CUSTOMISED SUPPLY



Item description	Code
Set for 1 shutter with a width of 865 mm (can be reduced to size) <u>without levers</u>	APE-150/4510. XXXX
Set for 1 shutter with a width of 1200 mm (can be reduced to size) <u>without levers</u>	APE-150/4511. XXXX
Set for 2 shutters with a width of 1200 mm (can be reduced to size) <u>without levers</u>	APE-150/4500. XXXX
Set for 2 shutters with a width of 1525 mm (can be reduced to size) <u>without levers</u>	APE-150/4515. XXXX
Set for 2 shutters with a width of 2000 mm (can be reduced to size) <u>without levers</u>	APE-150/4520. XXXX

XXXX = RAL-code for the chosen colour

Minimum quantity no.10 automations.

For more information contact customer service

SERVICE ON REQUEST: RHA AUTOMATION CUT TO SIZE

Code	Name	Item description
APE-150/45TM	RHACUT	Cut to size for box and cover, both on SET for 1 and 2 shutters

CUSTOMISED SUPPLY

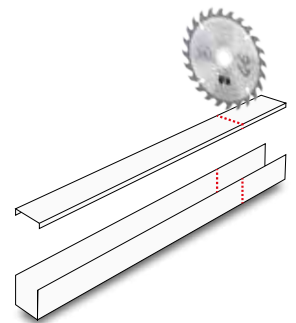

OPTIONAL RADIO CONTROL ACCESSORIES

Code	Name	Item description
APE-244/7200	WALL2	Wall transmitter 433.92 MHz for radio control of the automation
APE-150/4066	HOME	White 6-key/channel transmitter (433,92MHz) for RHA/SHU
APE-550/4040		Holder remote control for transmitter HOME



B
12

see ACCESSORIES page B29



PRICE LIST - SHUTTERS MOVEMENT LEVER KIT

To complete the SET, add the levers for shutters.

To be chosen according to the type of shutter opening, 1 lever for each shutter.



NORMAL SHUTTERS

Code / Name	Item description
-------------	------------------

APE-150/4530
RHAG

Sliding kit with guide and arm for 1 shutter (right or left) adjustable

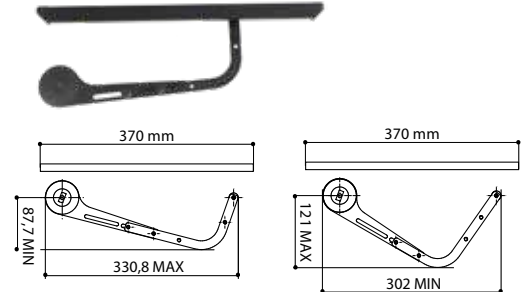

APE-150/4531
RHAG1

Sliding kit with guide and arm for 1 shutter (right or left) single-setting

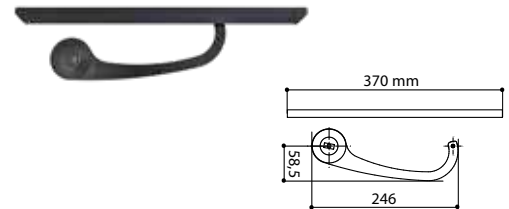

APE-150/4532
RHAG2

Sliding kit with guide and arm for 1 shutter (right or left) with shutter support skid, adjustable

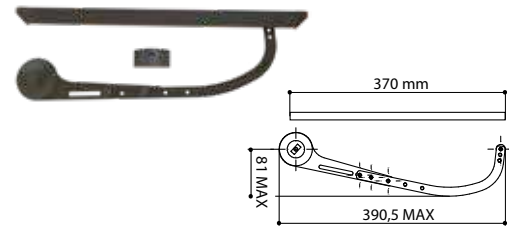

STANDARD SHUTTER SLIDE



STANDARD SHUTTER SLIDE



WITH LONGER SLIDING:
L=1000 - **RAHOX1000**



APE-150/4539
RAHOX1000

Slide length 1000 mm (instead of of the standard slide of RHAG, RHAG1 and RHAG2, of 370 mm)



SPLIT SHUTTERS / PADOVANA SHUTTERS / TREVIGIANA SHUTTER



see page B14

FOLDING SHUTTERS / BOUND SHUTTERS



see page B15

SPLIT SHUTTERS / PADOVANA SHUTTERS / TREVIGIANA SHUTTERS



Code / Name	Item description
APE-150/4533 RHAG3	T-compass lever arm for 1 shutter (right or left)

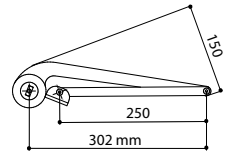
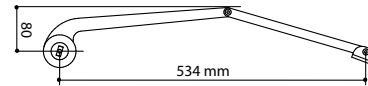

minimum light Lmin (with frame)		maximum light Lmax (without frame)		shutter weight (Kg)	depth P		shutters dimensions		
single shutter (mm)	double shutter (mm)	single shutter (mm)	double shutter (mm)		min (mm)	max (mm)	shutter width S (mm)	shutter 1 breadth (mm)	shutter 2 breadth (mm)
520	755	800	1600	30/40	from 155	to 175	up to a 35	up to 220	from 233
520	855				da 175		all		
		from 175	to 195		up to a 35	from 220, total between 1st and 2nd shutter, at least 250			
					da 195		all		

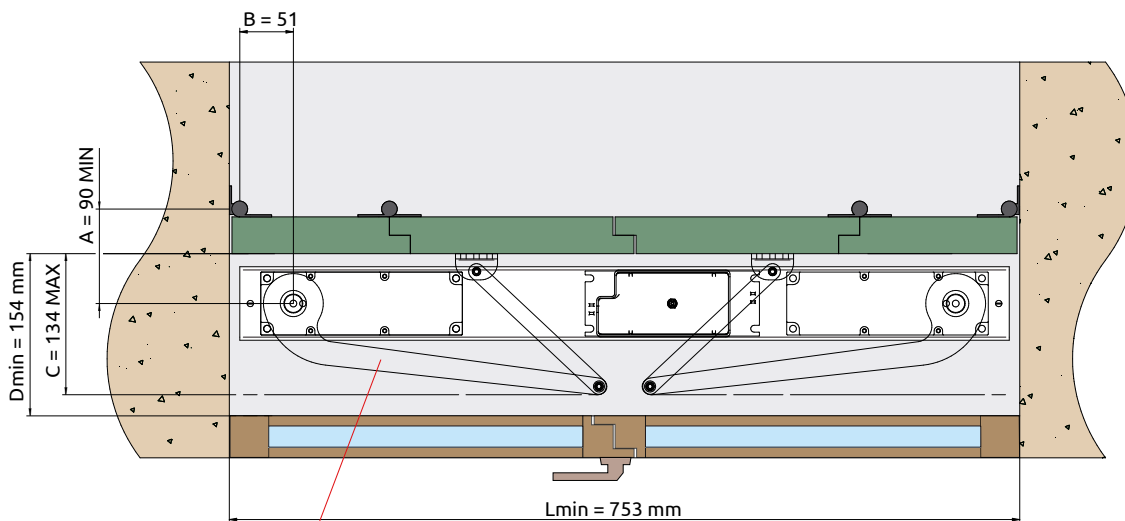
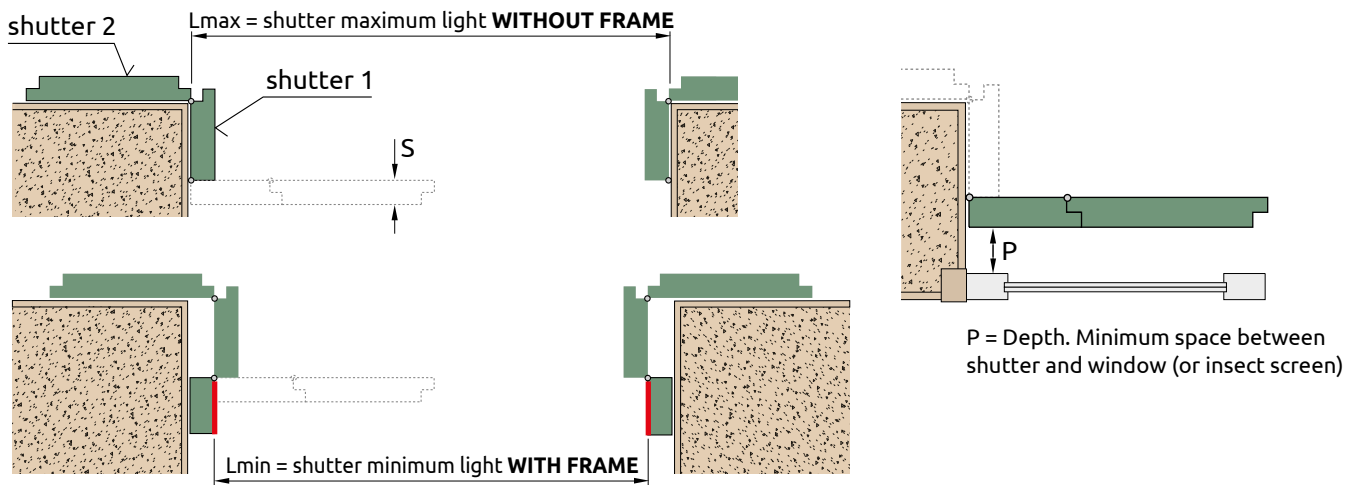

RHAG3 arm/lever

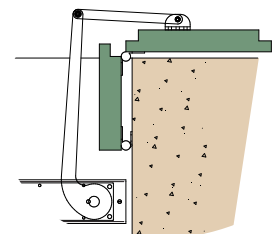

FOLDING SHUTTERS / BOUND SHUTTERS

In this case, select n.1 MOVEMENT LEVER + n.1 SHUTTER PACK GUIDE for each shutter



MOVEMENT LEVER



Code / Name	Item description
APE-150/4533 RHAG3	T-compass lever arm for 1 shutter (right or left)

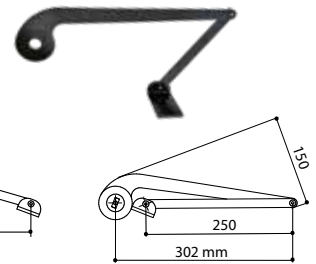

PACKET SHUTTERS GUIDE



Code / Name	Item description
APE-150/4538 RHAG4S	Sliding kit complete with guide and arm for 1 shutter (right or left), adjustable, SHORT version for FOLDING SHUTTERS with width from 30 to 55 cm



Code / Name	Item description
APE-150/4540 RHAG4L	Sliding kit complete with guide and arm for 1 shutter (right or left), adjustable, LONG version for FOLDING SASHES with width from 55 to 70 cm

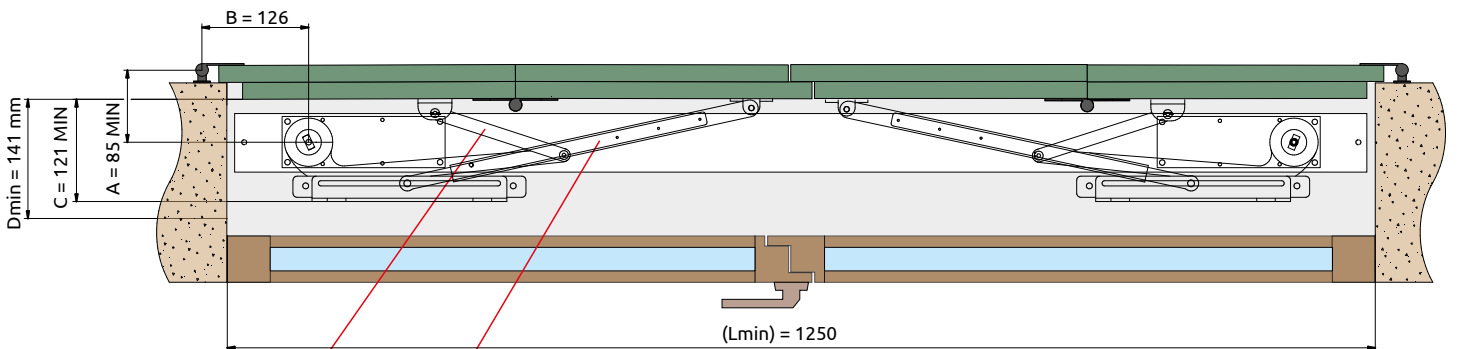
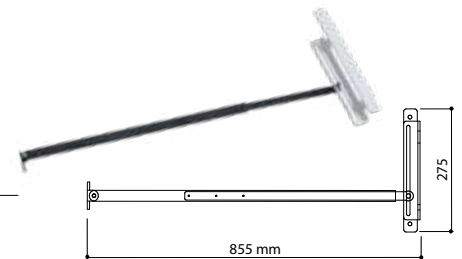

RHAG3 arm/lever
> code **APE-150/4533**

+ arm/lever RHAG4S (short)
> code **APE-150/4538**

Lmin = minimum beam width to be able to automate the shutter
A/B = distances from shutter hinge center to control lever center
C = min/max footprint of control lever, inward facing
Dmin = minimum distance from shutter to window

APPLICATION WITH MOUNTING ABOVE LINTEL

INTERIOR WINDOW APPLICATION



EXTERNAL APPLICATION



Application to be used in the case of obstructions in the window compartment such as the presence of security grilles or mosquito nets

For these applications, use the same automations as on page 6 (RHASET), to which, however, couple brackets and levers shown below

Accessories

Code	Name	Item description
APE-150/4574	RHASA2	Pair of right+left brackets For frontal fixing of the motor
APE-150/4535	RHAG5	Lever for opening/closing movement



OPTIONAL ACCESSORIES



ELECTRO BLOCK

Concealed electro-lock integrated into the box. The motors provide an important locking seal but are mechanically reversible, for this it is possible to add the electro-lock to ensure mechanical locking and thus safety.



Code	Name	Item description
APE-150/4580	RHALOK	12V electroblock, including accessories for installation



PARTICULAR APPLICATION WITH MOTOR ON THE SILL FOR WINDOWS ROUNDED AT THE TOP

BRACKETS FOR SIDE FIXING

Pair of right+left brackets for lateral fixing of the cassette. They are used where it is not possible to attach directly to the lower part of the beam.



Side-mounting dowels

Code	Name	Item description
APE-150/4572	RHASL	Pair of right+left brackets for lateral fixing of the cassette (dowels not included)



MINIMUM WIDTH RHA SYSTEM AUTOMATION

RHA system plan view

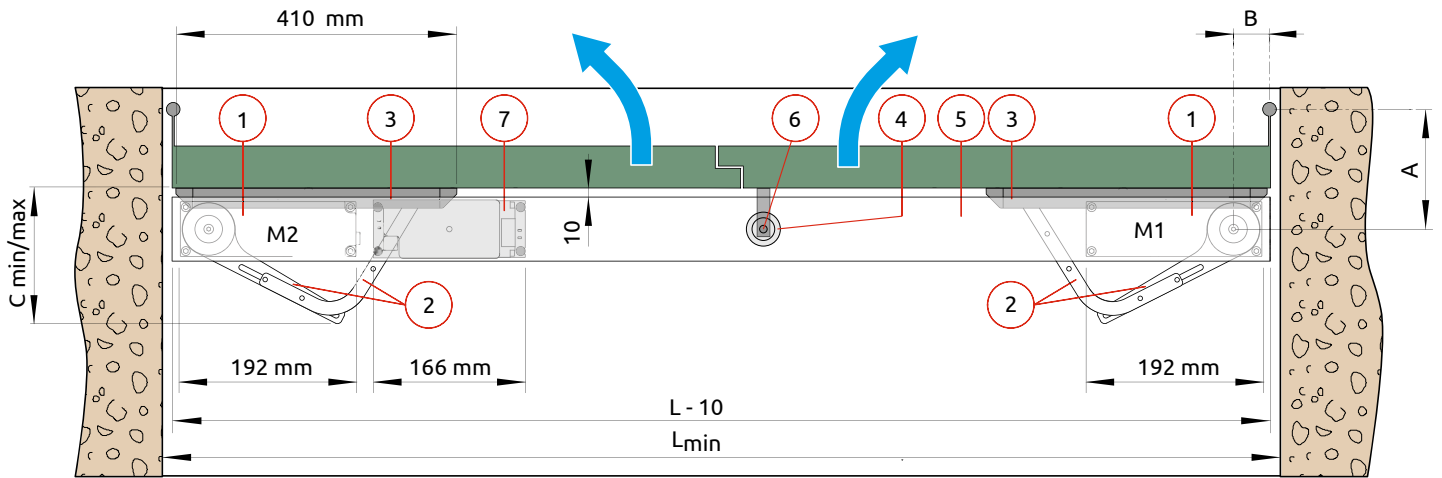

- [1] Gear Motor
- [2] Arms [RHAG-RHAG1-RHAG2-RHAG3-RHAG4S/L]
- [3] Slide guide on sash
- [4] Electric lock (optional)
- [5] Automation profile
- [6] Lock catch
- [7] Electronic panel

L_{min} = minimum beam width to be able To automate the shutter

L_{min} = 520 [1 shutter] - L_{min} = 420 with external electronic box
 L_{min} = 800 [2 shutters] - L_{min} = 630 with external electronic panel

A/B = distances from shutter hinge center to control lever center
 C = min/max footprint of control lever, inward facing
 M1/M2 = motors

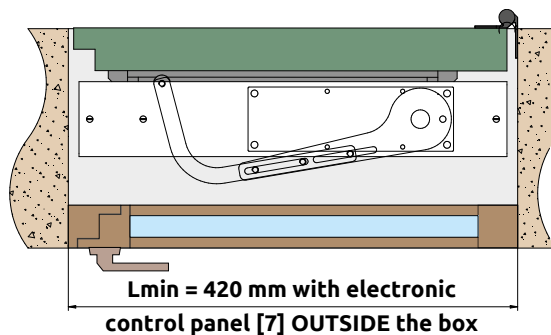
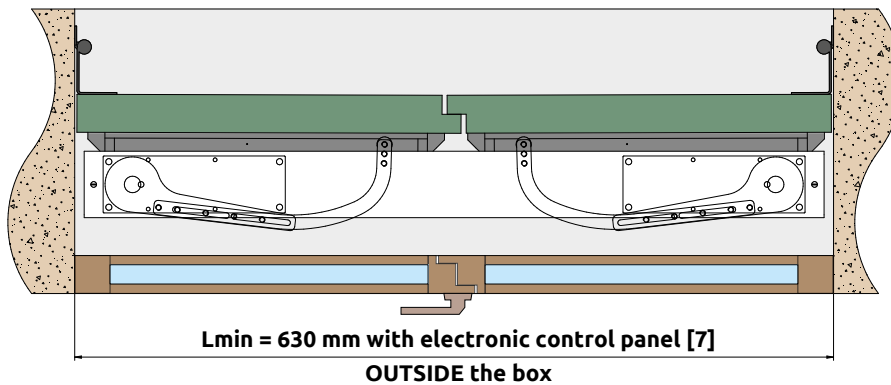

RHA PLUG-IN

The ideal solution
where energy does not reach



**AUTOMATION FOR HANGING SHUTTERS
POWERED BY RECHARGEABLE BATTERIES**

AUTOMATION FOR HINGED SHUTTERS POWERED WITH RECHARGEABLE BATTERIES

Power supply by BATTERY

No need for masonry work to bring power supply to the engine. It is sufficient to recharge the motor via the power supply unit (charger batteries)



Maximum strength for its category

Motor shaft output torque: 35Nm



SOLAR PANEL (optional)

The battery charge duration can be extended by the addition of a solar panel



POWER SUPPLY for battery charging

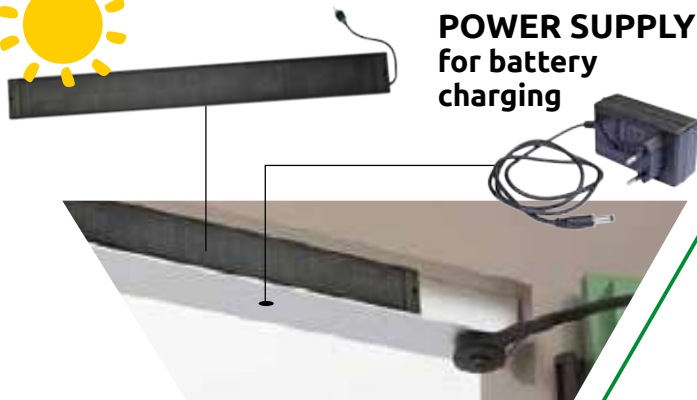

"Dead man" function

Holding down for more than 2 seconds on the opening or closing will FORCE the movement in any wind condition



Opening controls and central locking (standard)

Control unit easily integrated to home automation systems or to sensors (e.g. in case of rain all shutters are closed)



e.g. rain sensor (optional)

Control unit

Description	RHA2 POWER
Control panel	for 1 or 2 motors 12 Vdc
Radio receiver	built-in radio, 433 MHz
Power supply	6400 mAh battery pack
Duration of recharge	approx. 2 months *
Motor power supply	12 Vdc / 1,4 A
Electroblock	12 Vdc
Electronic obstacle detection	yes

* depends on the shutter weight and number of manoeuvres

HIGH QUALITY COMPONENTS

Certified excellence and superior quality for our components: with a **five-year warranty**, we ensure reliable and long-lasting performance for both **engine** and **control unit**. Our commitment to quality translates into peace of mind for the customer.



Gear motor

Control unit



To guarantee the **quality** and **traceability** of our products, we use matricular labels that **uniquely** identify each unit. This allows us to precisely monitor production and offer a personalised and secure service to our customers.

CERTIFIED SILENCE

In addition to the quality of our products, we can also certify the low noise of our mechanisms, achieved thanks to **precise mechanical and calibrated assembly**.

The RHA system offers a quiet and comfortable experience, proven by phonometric measurements, ensuring a quiet and pleasant environment in your home.

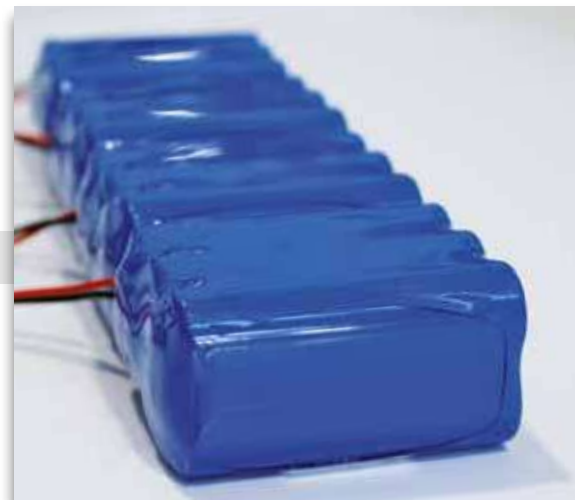

PRICE LIST - BATTERY-POWERED AUTOMATION SET

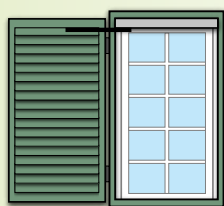

1 SHUTTER

Automation set for 1 hinged shutter (30 kg max)

The set contains, in a single package, automation and control accessories needed to make a single hinged shutter. Composition:

- no.1 actuators complete with control panel with built-in radio receiver
- no.1 rechargeable lithium **battery pack** (power supply not included, to be order separately as it is sufficient to have one for each home)
- aluminium support profile, aluminium and thermoplastic resin cover. In the standard version, the **aluminium is WHITE painted (RAL 9010)**.

STANDARD SUPPLY

WHITE painted aluminum (RAL9010)

Code	Name	Item description	Colour
APE-150/4405	RHASETM865 PLUG-IN	Set for 1 shutter with a width of 865 mm (can be reduced to size) <u>without levers</u>	
APE-150/4406	RHASETM1200 PLUG-IN	Set for 1 shutter with a width of 1200 mm (can be reduced to size) <u>without levers</u>	



Anodized aluminum (SILVER colour)

Code	Name	Item description	Colour
APE-150/4405.S	RHASETM865.S PLUG-IN	Set for 1 shutter with a width of 865 mm (can be reduced to size) <u>without levers</u>	
APE-150/4406.S	RHASETM1200.S PLUG-IN	Set for 1 shutter with a width of 1200 mm (can be reduced to size) <u>without levers</u>	



GREEN painted aluminum (RAL 6005)

Code	Name	Item description	Colour
APE-150/4405.6005	RHASETM865.6005 PLUG-IN	Set for 1 shutter with a width of 865 mm (can be reduced to size) <u>without levers</u>	
APE-150/4406.6005	RHASETM1200.6005 PLUG-IN	Set for 1 shutter with a width of 1200 mm (can be reduced to size) <u>without levers</u>	



BROWN painted aluminum (RAL 8017)

Code	Name	Item description	Colour
APE-150/4405.8017	RHASETM865.8017 PLUG-IN	Set for 1 shutter with a width of 865 mm (can be reduced to size) <u>without levers</u>	
APE-150/4406.8017	RHASETM1200.8017 PLUG-IN	Set for 1 shutter with a width of 1200 mm (can be reduced to size) <u>without levers</u>	



The RAL paint is supplied with a standard gloss value of 30/40 GU.

Other RHASET PLUG-IN colours > see page B24

PRICE LIST - BATTERY-POWERED AUTOMATION SET

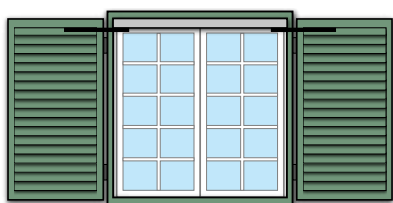

2 SHUTTERS



Automation set for 2 hinged shutters (30Kg x 2 shutters = 60 kg max)

The set contains, in a single package, automation and control accessories needed to make a two-hinged shutter. Composition:

- no.2 actuators complete with control panel with built-in radio receiver
- no.1 rechargeable lithium **battery pack** (power supply not included, to be order separately as it is sufficient to have one for each home)
- aluminium support profile, aluminium and thermoplastic resin cover. In the standard version, the **aluminium is WHITE painted (RAL 9010)**.



STANDARD SUPPLY 

WHITE painted aluminum (RAL9010)

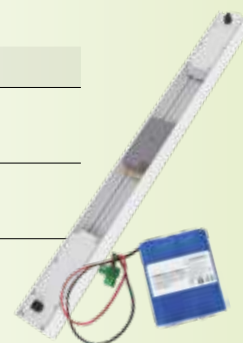
Code	Name	Item description	Colour
APE-150/4410	RHASETD1200 PLUG-IN	Set for 2 shutters with a width of 1200 mm (can be reduced to size) <u>without levers</u>	
APE-150/4425	RHASETD1525 PLUG-IN	Set for 2 shutters with a width of 1525 mm (can be reduced to size) <u>without levers</u>	



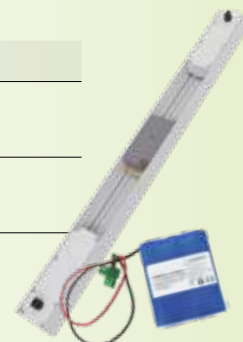

Anodized aluminum (SILVER colour)

Code	Name	Item description	Colour
APE-150/4410.S	RHASETD1200.S PLUG-IN	Set for 2 shutters with a width of 1200 mm (can be reduced to size) <u>without levers</u>	
APE-150/4425.S	RHASETD1525.S PLUG-IN	Set for 2 shutters with a width of 1525 mm (can be reduced to size) <u>without levers</u>	



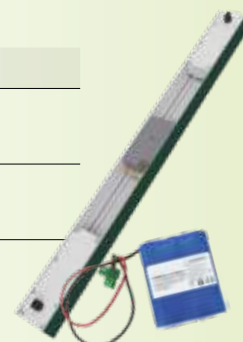

GREEN painted aluminum (RAL 6005)

Code	Name	Item description	Colour
APE-150/4410.6005	RHASETD1200.6005 PLUG-IN	Set for 2 shutters with a width of 1200 mm (can be reduced to size) <u>without levers</u>	
APE-150/4425.6005	RHASETD1525.6005 PLUG-IN	Set for 2 shutters with a width of 1525 mm (can be reduced to size) <u>without levers</u>	



BROWN painted aluminum (RAL 8017)

Code	Name	Item description	Colour
APE-150/4410.8017	RHASETD1200.8017 PLUG-IN	Set for 2 shutters with a width of 1200 mm (can be reduced to size) <u>without levers</u>	
APE-150/4425.8017	RHASETD1525.8017 PLUG-IN	Set for 2 shutters with a width of 1525 mm (can be reduced to size) <u>without levers</u>	

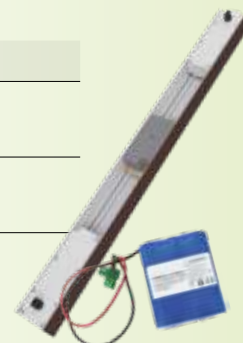

The RAL paint is supplied with a standard gloss value of 30/40 GU.

Other RHASET PLUG-IN colours > see page B24

Other RHASET colours
RHASET automations can also be requested with RAL supplied by the customer. The RAL paint is supplied with a standard **gloss value of 30/40 GU**.



Item description	Code
Set for 1 shutter with a width of 865 mm (can be reduced to size) <u>without levers</u>	APE-150/4405. XXXX
Set for 1 shutter with a width of 1200 mm (can be reduced to size) <u>without levers</u>	APE-150/4406. XXXX
Set for 2 shutters with a width of 1200 mm (can be reduced to size) <u>without levers</u>	APE-150/4410. XXXX
Set for 2 shutters with a width of 1525 mm (can be reduced to size) <u>without levers</u>	APE-150/4425. XXXX

XXXX = RAL-code for the chosen colour

Minimum quantity no.10 automations.
For more information contact customer service

CUSTOMISED SUPPLY 

RHA PLUG-IN POWER SUPPLY FOR 1 AND 2 SHUTTERS

Code	Name	Item description
APE-150/4488	RHAPS	Power supply (battery charger) 12V, 5A for RHASET PLUG-IN
APE-150/4490	RHASUN	OPTIONAL - Solar panel for RHASET PLUG-IN 10 Watt, dimensions 55,3x6hx1 cm



RHA AUTOMATION CUT TO SIZE

Code	Name	Item description
APE-150/45TM	RHACUT	Cut to size for box and cover, both on SET for 1 and 2 shutters

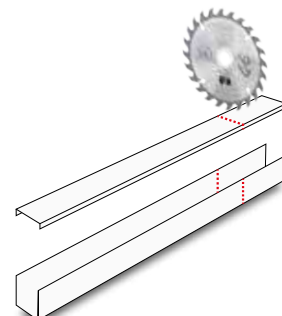

CUSTOMISED SUPPLY 

OPTIONAL RADIO CONTROL ACCESSORIES

Code	Name	Item description
APE-244/7200	WALL2	Wall transmitter 433.92 MHz for radio control of the automation
APE-150/4066	HOME	White 6-key/channel transmitter (433,92MHz) for RHA/SHU
APE-550/4040		Holder remote control for transmitter HOME



see ACCESSORIES page B29

PRICE LIST - SHUTTERS MOVEMENT LEVERS KIT

To complete the SET, add the levers for shutters (RHAG, RHAG1, RHAG2, RHAG3).
To be chosen according to the type of shutter opening, 1 lever for each shutter.

NORMAL SHUTTERS



Code / Name	Item description	
APE-150/4530 RHAG	Sliding kit with guide and arm for 1 shutter (right or left) adjustable	
APE-150/4531 RHAG1	Sliding kit with guide and arm for 1 shutter (right or left) single-setting	
APE-150/4532 RHAG2	Sliding kit with guide and arm for 1 shutter (right or left) with shutter support skid, adjustable	
APE-150/4539 RHAOX1000	Slide length 1000 mm (instead of of the standard slide of RHAG, RHAG1 and RHAG2, of 370 mm)	

for more information about the slide, see page B13

SPLIT SHUTTERS / PADOVANA SHUTTERS / TREVIGIANA SHUTTERS



see page B14



FOLDING SHUTTERS / BOUND SHUTTERS



see page B15



ATTENTION:

TO AVOID OVERLOADING PROBLEMS AND TO AVOID DRASTICALLY DECREASING BATTERY USE TIME, DO NOT CONNECT OTHER RECEIVERS OR POWERED ACCESSORIES TO THE BATTERY



WARNING:

IF THE BATTERY IS INSTALLED IN THE PRESENCE OF RADIO ALARMS OR OTHER SOURCES WITH A 433 MHz FREQUENCY, IT MAY HAVE A SHORTER DURATION.

AUTOMATIONS FOR SLIDING SHUTTERS

Reduced overall dimensions to a minimum for its category

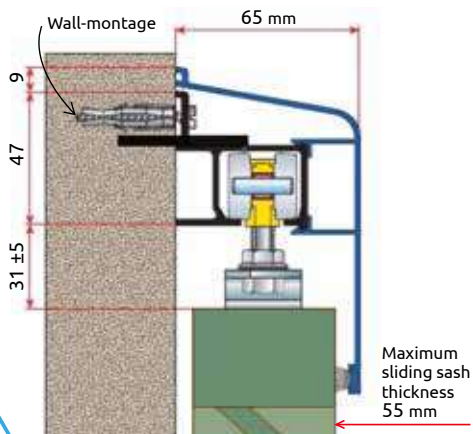

Maximum strength for its category

Motor shaft output torque: 12Nm



Maximum security

Thanks to the irreversible motor the sashes cannot be forced in opening



"Dead man" function

Holding down for more than 2 seconds on the opening or closing will FORCE the movement in any wind condition



Opening controls and central locking (standard)

Control unit easily integrated to home automation systems or to sensors (e.g. in case of rain all shutters are closed)



e.g. rain sensor (optional)



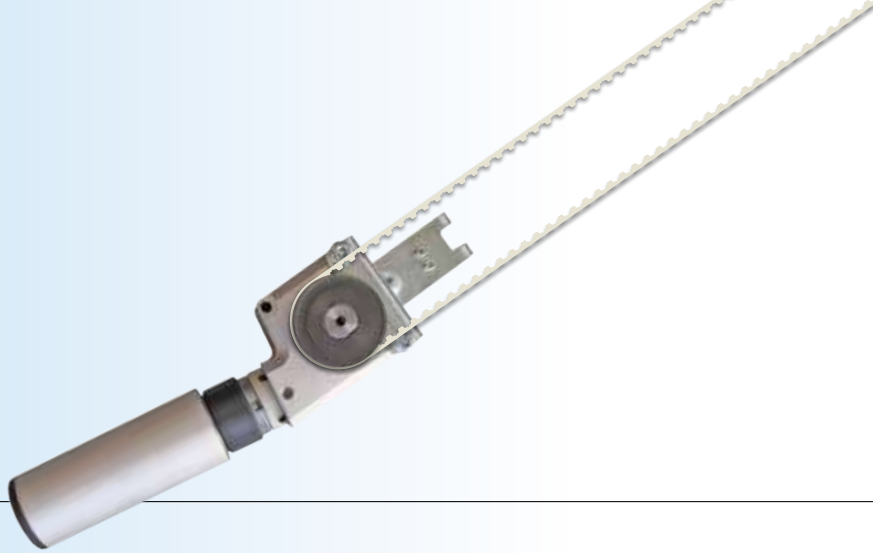

SHU

Automations for sliding shutters

Thanks to the system for sliding shutters, everyday movements will be even easier and more comfortable. The SHU system allows the movement of a double-shutter or swing automation single shutter of a new installation. The outer casing protects and conceals the mechanical and electronic components of the system, making the automation more secure without sacrificing elegance.



SHU is an ancient Egypt God, personification of the air, the atmosphere and wind

Features and functions

Gear motor

Description	SHUM12
Electromechanical actuator	Automations for sliding shutters
Maximum capacity	90 Kg (1 anta) 60+60 Kg (2 ante)
Service class	2 - light
Intermittency	S2 = 7 min / S3 = 15%
Power supply	12 Vdc
Power consumption	0,38 A
Operating temperature	-20°C / +55°C
Degree of protection (with aluminum profile)	IP 44
Control panel	SHU2
External box dimensions	152x152x45 mm

Control unit

Description	SHU2
Control panel	for 1 or 2 motors 12 Vdc with built-in radio
Power supply	230 Vac / 50-60Hz
Energy saving	reduced consumption in stand-by and during use
Number of motors	1 or 2
Motor power supply	12 Vdc / 1,4 A
Electroblock	12 Vdc
ODS - Obstacle detection (causes stop or reversal of the maneuver if obstacle is detected)	Yes
Opening command	Yes
Closing command	Yes
Dead man command	Yes
Centralized opening command	Yes
Centralized closing command	Yes



Special low-noise gear motor



Gear motor



Control unit

Local and centralized controls via cable, radio (433 MHz)

KIT supplies

1 SHUTTER

Automation set for single sliding shutter weighing up to 90Kg

The set contains automation and accessories needed to make a single-shutter shutter sliding shutter. Composition:

- no.1 control unit with switching power supply 230 Vac/12 Vdc
- no.1 gearmotor
- no.1 polyurethane belt
- no.1 idler pulley



Code	Name	Item description
APE-150/4001	SET1L	(*) Automation set for no.1 sliding door with gearmotor and control unit (integrated receiver)
APE-150/4025	G25	Aluminum guide with casing of 2.5 m. length for no.1 sliding shutter. No.2 load-bearing carts.



2 SHUTTERS

Automation set for 2-leaf sliding shutters with weight up to 60+60Kg

The set contains automation and accessories needed to make a two-leaf sliding shutter. Composition:

- no.1 control unit with switching power supply 230 Vac/12 Vdc
- no.1 gearmotor
- no.1 polyurethane belt
- no.1 idler pulley

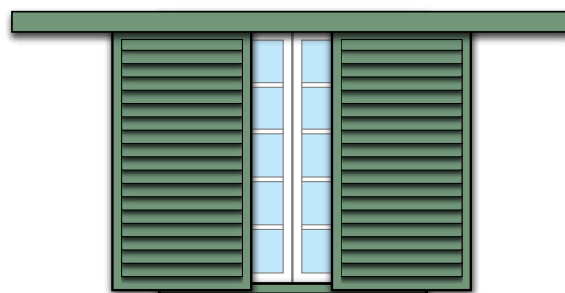

Code	Name	Item description
APE-150/4002	SET2L	(*) Automation set for no.2 sliding doors with gearmotor and control unit (integrated receiver)
APE-150/4040	G40	Aluminum guide with casing of 4 m. length for no.2 sliding shutters. No.4 load-bearing carts.



OPTIONAL RADIO CONTROL ACCESSORIES

Code	Name	Item description
APE-244/7200	WALL2	Wall transmitter 433.92 MHz for radio control of the automation
APE-150/4066	HOME	White 6-key/channel transmitter (433,92MHz) for RHA/SHU
APE-550/4040		Holder remote control for transmitter HOME



(*) WARNING: ABTECNO does not provide service or guarantee of proper operation on SET1L / SET2L items if installed on tracks other than those indicated in the catalog



PLANO TWO

WiFi receiver

Universal receiver that can be controlled via radio (433 MHz) and via WiFi, required for the use of the **ONESMART** remote control app

Description	PLANO TWO
Power supply	12 Vdc
Output channels	2
Dimensions	70x60mm

Code	Name	Item description
APE-244/6121	PLANO TWO	Universal receiver that can be controlled via radio (433 MHz) and via WiFi. No.2 relay outputs to drive opening and closing

**Remote control
100% SMART**



ONESMART



Remote Control

It is possible to control the devices remotely, from anywhere in the world via smartphone or with voice commands via Google Home and Amazon Alexa.



Smart Automation

With OneSmart, it is easy to create scenarios and events with simple programming that predicts the occurrence of an action at a given condition.



RAINS

Rain Sensor

Stand-alone rain sensor with relay output for controlling windows and doors

Description	RAINS
Power supply	12 Vdc
Degree of protection	IP 44
Dimensions	117x60x22 mm

Code	Name	Item description
APE-330/0312	RAINS	Stand-alone rain sensor with dry contact output



WINDS 230

Wind Sensor (Anemometer)

Wind sensor to be combined with control panel for the emergency maneuvering (locking for windows and doors)

Description	WINDS 230
Power supply	No
Degree of protection	IP 44
Dimensions	110x110x110 mm

Code	Name	Item description
APE-528/4230	WINDS 230	Stand-alone wind sensor 230v, with power supply unit

1. Effectiveness of these general conditions of sale

These General Conditions of Sale apply to all orders relating to products with the Abexo brand, addressed to Ab Tecno srl (hereafter: Ab Tecno srl). For distributed brands, the sales conditions of the manufacturer are valid, if present. All sales from Ab Tecno to Customers (hereafter: Customer) are governed by the following General Conditions of Sale, which are an integral part of the sales contract and replace and cancel any contrary special clause or agreement in the order or in another document from the Customer.

2. Orders

All orders are “subject to availability and change of price lists”. Ab Tecno reserves the right to accept or refuse, in whole or in part, the orders of the Customer in reason of their conformity or not with the present general conditions and the availability of the requested products. Ab Tecno reserves the right to make at any time technical changes to the products in the price list, without this generating any claim by the Customer.

Orders can not be canceled in whole or in part by the Customer after 5 days from their transmission to Ab Tecno srl; in case of cancellation after this term, Ab Tecno srl will be entitled to the entire indemnity.

3. Prices

The products are sold by Ab Tecno to the customer at the Ab Tecno srl price list in force at the time of delivery. The Customer undertakes to accept without reserve the eventual variations of the list intervened between the order and the delivery of the product.

Each new Ab Tecno price list cancels and replaces the previous ones. Ab Tecno srl list prices are always intended ex-works, excluding VAT.

4. Terms of delivery

- All products are delivered ex-works, Ab Tecno warehouse.
- Unless otherwise agreed in writing with Ab Tecno, the delivery terms are 30 working days from the order accepted by Ab Tecno.
- Any delay not exceeding the tolerances of use will not entitle the Customer to request the termination, even partial, of the contract, to refuse the delivery of products or request compensation for damages.
- The obligation to deliver the goods is fulfilled with delivery to the carrier.
- Ab Tecno is freed from the obligation to deliver the goods in all cases of fortuitous event or force majeure, strikes or the impossibility of procurement of raw materials or other unavailability of products, and in any case when events occur that prevent delivery of the goods without fault of Ab Tecno srl.

5. Shipments

- Shipments will be made by courier agreement with Ab Tecno, which will automatically charge the relative amount on the invoice. When ordering it will be possible to agree with Ab Tecno the use of a different courier, always at the expense of the Customer, or the direct collection of the goods, ex factory Ab Tecno srl.
- The goods always travel at the total risk and danger of the customer. Possible thefts, losses, deterioration or missing goods don't exonerate the customer from the obligation to pay the price, if the goods have been regularly delivered from Ab Tecno factory to the carrier.
- The goods are not covered by insurance policy, unless expressly requested by the customer, and at his own expense and risk.

6. Collection of products

The Customer undertakes to collect the goods as soon as they have been made available to them. In case of delay, Ab Tecno will be entitled - in addition to the integral payment of the price - the reimbursement of storage or rest and storage costs of the goods, except for compensation for damages. Ab Tecno does not answer of the damages that, directly or indirectly, derive from the stock of the goods not withdrawn or withdrawn late, both in Ab Tecno warehouses that in those of freight forwarders or transporters or others.

7. Warranty

- All the equipment on the price list are carefully checked and tested: Ab Tecno guarantees its products, under the Ab Tecno srl trademark or any other brand, against the defects of the material used or the manufacture according to the conditions and limits of installation and use indicated by Ab Tecno.

• The duration of the guarantee is:

- 1) 60 months from the date of manufacture affixed valid on products of the brand BEEMATIC: gear motors, control units (RHA2 e SHU2), automation sets and lever kits for swing shutters (excluding batteries) and radio transmitters.
- 2) 24 months from the date of manufacture affixed valid on products of the brand BEEMATIC: control units (RHA2 POWER) and for BEEMATIC products batteries.
- 3) The warranty includes only the repair or replacement of the product considered defective according to Ab Tecno: it remains excluded from the warranty any other damage or expense of any nature incurred by the customer. All replaced products will remain the Ab Tecno property anyway.

Ab Tecno assumes no responsibility for problems arising from incorrect installation of the products. It is always indispensable that the person carrying out the installation complies with the safety regulations in force and has the necessary technical knowledge and capacity to perform the installation properly.

Ab Tecno assumes no responsibility in the event of failure to comply with the assembly and electrical connection instructions, or electrical or other specific regulations in force at the time of installation, as well as accessories and electrical or mechanical components of Ab Tecno have been installed, used or connected without respecting the patterns and types of connections for which they were designed. Likewise Ab Tecno assumes no responsibility in case of use or application of the products for purposes that are not appropriate to the nature, capacity and degree of flow of Ab Tecno products.

For products no longer under warranty Ab Tecno srl provides an assistance service for the repair of the equipment, with charge of the relative expenses. In the case of non-repairable equipment, Ab Tecno srl may, at its sole discretion, provide for their replacement, charging them each related cost to the customer.

8. Complaints and responsibilities for defective products

- Possible claims for shortages or failures apparent from the external examination of the packages containing the goods must be elevated, under penalty of forfeiture, upon receipt of the goods themselves, by means of a note signed by the purchaser and affixed to the delivery documentation. any claims for other defects of conformity of the goods, not detectable by the external examination of the packages, must be communicated to Ab Tecno, under penalty of forfeiture, by registered letter with acknowledgment of receipt, to be sent within 60 days of delivery of the products.

- In any case, merchandise returns are not allowed without the prior written consent of Ab Tecno. Ab Tecno is exonerated from any other responsibility, and in particular, from any liability for damage to property or other emerging damage or for loss of profit, direct or indirect. Furthermore, no complaint can give right to the delay or suspension of payment terms, which must in any case be made in full on what is not contested.

9. Reservation of the property

- Ab Tecno srl reserves the ownership of the goods sold until full payment. Therefore, until full payment of the price has occurred for capital and accessories, the goods delivered, wherever they are and even if they have already been resold by the customer, will remain in full and exclusive property of Ab Tecno srl.
- Checks, promissory notes and credit transfers will not be considered as payments made effective from actual collection. In case of failure Payment Ab Tecno srl can resume the immediate possession of products sold wherever they are. The Customer is obliged to communicate the names third party buyers of the products in which Ab Tecno srl will have the right to claim them and to withdraw them.

10. Payment conditions

- All payments must be made exclusively to Ab Tecno srl, and executed according to the terms and methods indicated on the invoice.
- INTERESTS OF MORA: failure to comply with the deadline set for payment will result in default interest charged to the Customer, in the measure established by the D.L. 9.10.2002, N.231, implementation of the community directive n. 2000/35 / EC, and in any case within the maximum limits of the regulations in force, without the need for communication or formal notice.
- FACULTY OF WITHDRAWAL AND SUSPENSION OF THE EXECUTION: in case of delay in the payment of even one of the agreed installments and deadlines, Ab Tecno srl reserves the right to suspend - even without notice - the execution/delivery of the order, and/or to withdraw from any contracts in progress, even if different from those to which the non-payment refers, without the Customer's right to indemnity or compensation of any kind. Failure to pay within the agreed terms will also entitle Ab Tecno srl to make further deliveries subject to the full payment of the price expired with related interest, and of the expiring one, due to the expiry of the Customer from the benefit of the term on subsequent payments or the simultaneous provision of adequate guarantees. The same faculties belong to Ab Tecno srl whenever changes occur in the person of the purchaser, in its structure or social structure, patrimonial situation or consistency or commercial image, as well as in cases of elevation of protests, slope of executive procedures or bankruptcy, issue of payment orders, suspensions, deferments or delays in the performance of obligations to third party creditors. COMPENSATION: It is not allowed, unless otherwise expressly accepted in writing, any compensation between any credits claimed by the Customer in comparisons of Ab Tecno srl and the debts of the same Customer, for whatever title, deriving, inherent and/or consequent the contract of sale.

11. Patents, trademarks and distinctive signs

The Customer is aware that Ab Tecno srl products are covered by patents and are subject to Know How and Design constituting industrial property exclusive of Ab Tecno srl. It is expressly forbidden to the customer to violate these rights of Ab Tecno srl and in any case to remove, suppress or otherwise alter trademarks and other distinctive signs or acronyms of any kind affixed to the products, as well as of new ones of any nature. Unless authorized writtenly by Ab Tecno srl, any form of reproduction or use of the Ab Tecno srl trademark and any other distinctive mark on the products is forbidden.

12. Resolution clause

In case of non-payment of the price, the sale can be settled in full right at any time with the simple written communication of Ab Tecno srl to the customer to make use of this clause and without the need for no judicial formalities. The goods delivered and not paid must be returned to Ab Tecno srl at the expense of the customer. To this end, Ab Tecno srl, and the third party contractors in charge, are authorized to withdraw and withdraw the goods from the customers' premises.

13. Approvals

Ab Tecno srl products report the data necessary for the identification of the certifications obtained. Knowledge and compliance with any regulations that regulate the use of the charges to be charged to the installer and / or user.

14. Italian law and competent court

For any controversy that arises in the execution of the contract it is convenient to apply the Italian Law and the jurisdiction for the territory in exclusive way of the Italian Judge, Court of Bologna.



www.beematic.it

BEEMATIC is a registered trademark owned by



AB Tecno srl

Via Cicogna, 95

40068 San Lazzaro di Savena (Bologna) - Italy

Tel. +39 051/6259580

info@abtecno.com

edition 4 rev.0 - 3/2016